

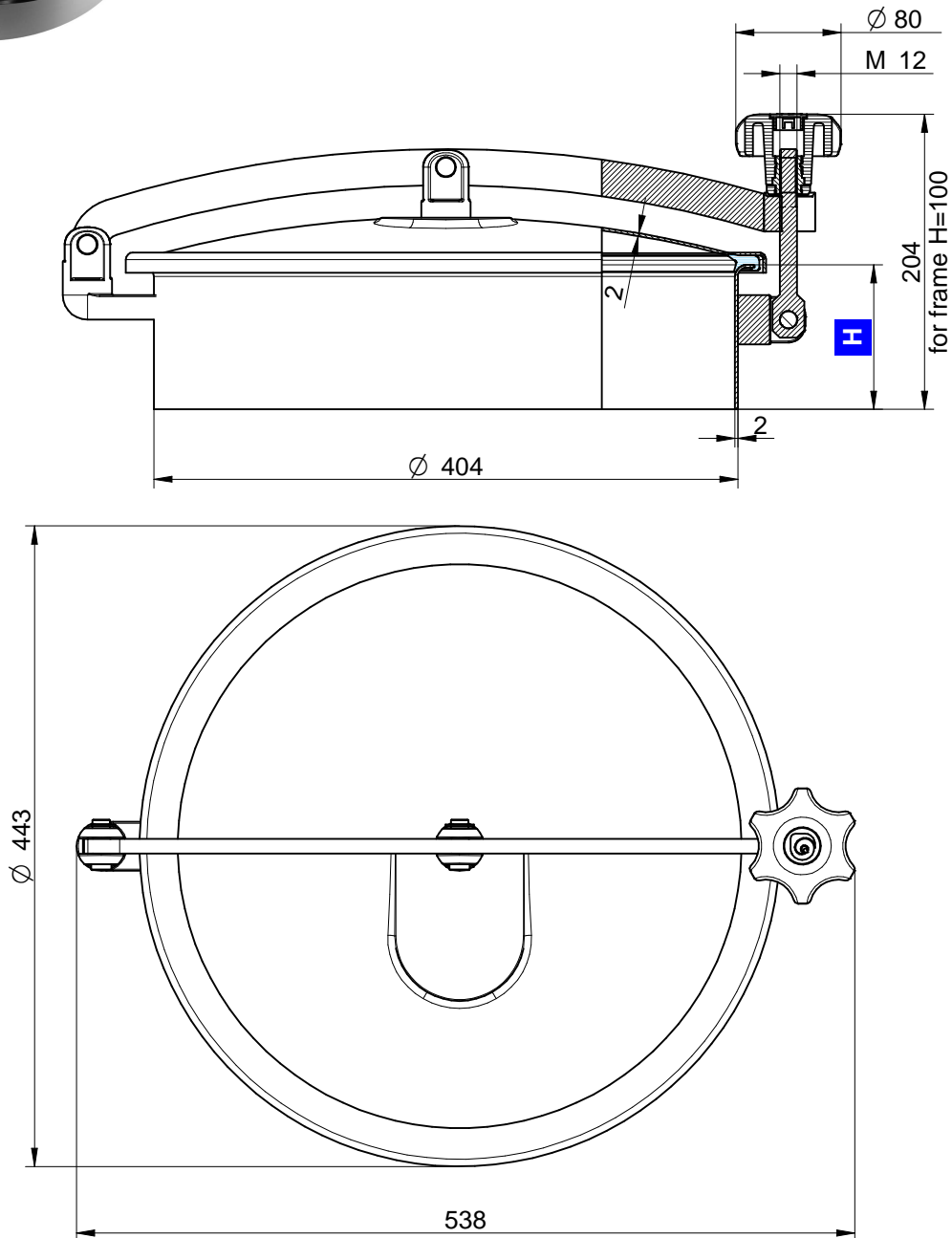

mod. T1A/400



H Frame height

Mod.	H (mm)	P. max (bar)	Weight (Kg)
T1A/400	65	-0,7 / 0,1	6,8
T1A/401	100	-0,7 / 0,1	7,5
T1A/402	150	-0,7 / 0,1	8,5
T1A/403	200	-0,7 / 0,1	9,5

MATERIAL: AISI 304L-14307 / AISI 316L-14404

Caratteristiche tecniche, pesi e prestazioni non sono vincolanti ed impegnativi. La Società si riserva inoltre di apportare ai prodotti le modifiche ritenute più opportune, senza alcun obbligo di preavviso.

Technical features, weights and performances are non-binding. The Company also reserves the right to make the appropriate changes to the products, without obligation of notice.