

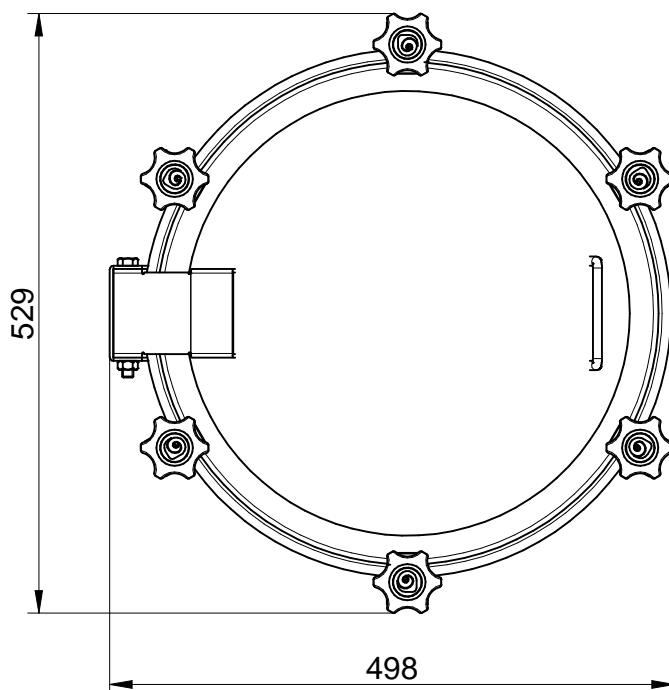

mod. 6V/250

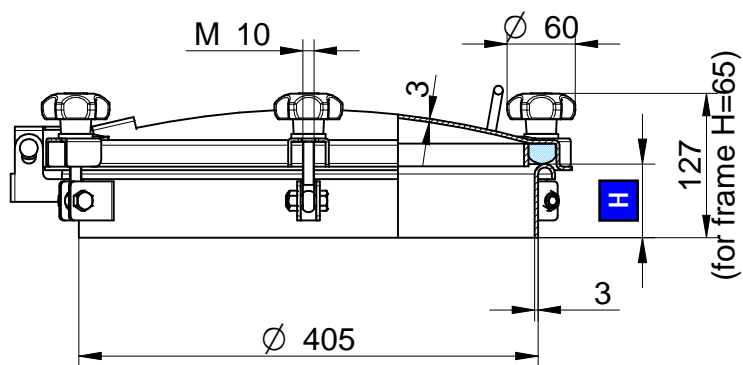

H Frame height

Mod.	H (mm)	P. max (bar)	Weight (Kg)
6V/250	65	-0,7 / 1,2	11,3
6V/251	100	-0,7 / 1,2	12,3
6V/252	150	-0,7 / 1,2	14,2
6V/253	200	-0,7 / 1,2	15,3

MATERIAL: AISI 304L-14307 / AISI 316L-14404

Caratteristiche tecniche, pesi e prestazioni non sono vincolanti ed impegnativi. La Società si riserva inoltre di apportare ai prodotti le modifiche ritenute più opportune, senza alcun obbligo di preavviso.

Technical features, weights and performances are non-binding. The Company also reserves the right to make the appropriate changes to the products, without obligation of notice.